

PPC- 3211SW / PPC-3181SW Sales Kit

Fanless 21.5" / 18.5" Panel PC
with Intel 6th Gen Core I CPU

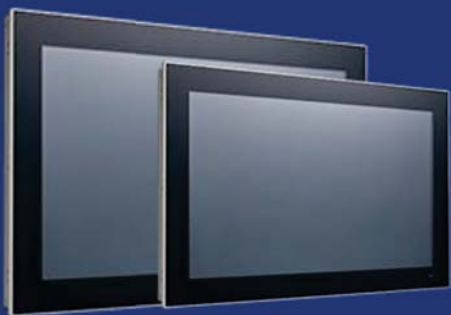

Enabling an Intelligent Planet

ADVANTECH

Features



- **Industrial** wide screen display
- True flat & IP65 front Panel
- P-Cap Multi-touch screen
- Power indicator LED on front



- Powered by **Intel 6th Gen Core i** processor
- Optimized thermal design on rear cover

- **Essential I/O ports**
- **Wide range of power input**
- **Enhanced ESD protection (Level 4)**

- **Fanless Design w/ solid Al Alloy enclosure**
- **Panel mounting/VESA 100 support**
- **2 x 1W speaker**

Less Volume, More Power

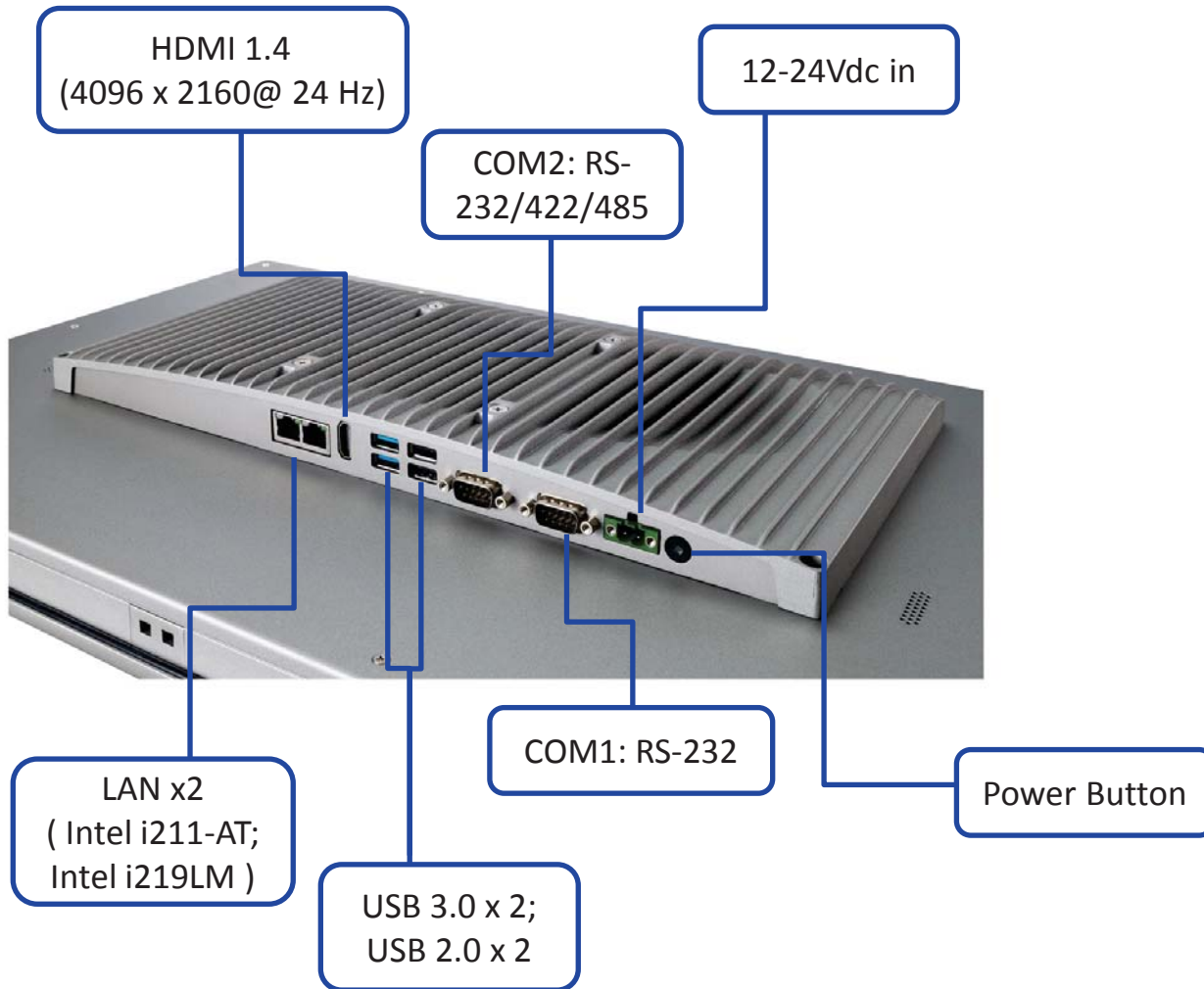

Features

- Intel 6th Gen Core i5-6300U processor (i7-6500U or i3-6100U optional)
- Wide range DC power input
- Dual 10/100/1000Mbps Ethernet port
- 1 x HDMI 1.4
- 1 x mSATA or 1 x 2.5" SSD storage
- 1 x mini PCIe expansion for wireless card

Benefits

- ✓ High CPU performance at lower power
- ✓ Enhanced power coverage of wiring loss and ground noise to protect system stable operating
- ✓ Dual display for monitoring
- ✓ Reliable ethernet access powered by Intel chip
- ✓ Slim and robust mechanical protection(ESD level 4)

Specifications

		PPC-3211SW	PPC-3181SW
LCD Display	Display Type	21.5" FHD TFT LCD (LED Backlight)	18.5" TFT LCD (LED Backlight)
	Resolution	1920 x 1080	1366 x 768
	Luminance (cd/m2)	300	450
	Contrast Ratio	5000	1000
	Backlight Lifetime	50,000 hrs	50,000 hrs
Touch screen	Touch Type	Projected Capacitive Multi-Touch 10 Point	Projected Capacitive Multi-Touch 10 Point
	Light Transmission	90 % ± 3 %	90 % ± 3 %
Processor System	CPU	Intel 6th Gen Core i5-6300U, dual core . (Core i7-6500U/i3-6100U optional)	
	Memory	1 x SO-DIMM DDR4 1866/2133 MHz (max. 16 GB) (1.2 V)	
	Storage	1 x 2.5" SATA Bay; 1 x mSATA Bay	
	Network (LAN)	2 x 10/100/1000 Mbps Ethernet (Intel I211-AT; Intel I219LM)	
	I/O ports	2 x Serial ports: 1 x RS-232, 1 x RS-232/422/485(Adjustable through BIOS) 2 x USB 3.0, 2 x USB 2.0; 1 x HDMI	
	Speaker	2 x 1W	
	Expansion	1 x Full size Mini PCIe slot	
	OS Support	Windows 7/8.1/10, WES7, Linux	

PPC-3211SW

PPC-3181SW

	PPC-3211SW	PPC-3181SW	
Physical Characteristics	Dimension	558.4 x 349.8 x 62.2 mm (21.9" x 13.7" x 2.4")	488 x 309 x 61.7 mm (19.2" x 12.1" x 2.4")
	Weight	6.8Kg (14.9lb)	5.9 kg (13lb)
Power Consumption	Input Voltage	12 ~ 24 Vdc	12 ~ 24 Vdc
	Power Consumption	75W	65W
Environment	Operating Temperature	0 ~ 50° C (32 ~ 122° F) with SSD 0 ~ 45° C (32 ~ 104° F) with HDD	
	Storage Temperature	-20 ~ 60° C (-4 ~ 140° F)	
	Relative Humidity	10 ~ 95% @ 40° C (non-condensing)	
	Shock	Operating 10 G peak acceleration (11 ms duration), follow IEC 60068-2-27	
	Vibration	Operating Random Vibration Test 5 ~ 500Hz, 1Grms @with HDD; 2Grms @with SSD, follow IEC 60068-2-64	
	EMC	CE, FCC Class B, BSMI	
	Safety	CB, CCC, BSMI, UL	
Front Panel Protection	IP65 compliant		

Dimensions of PPC-3211SW

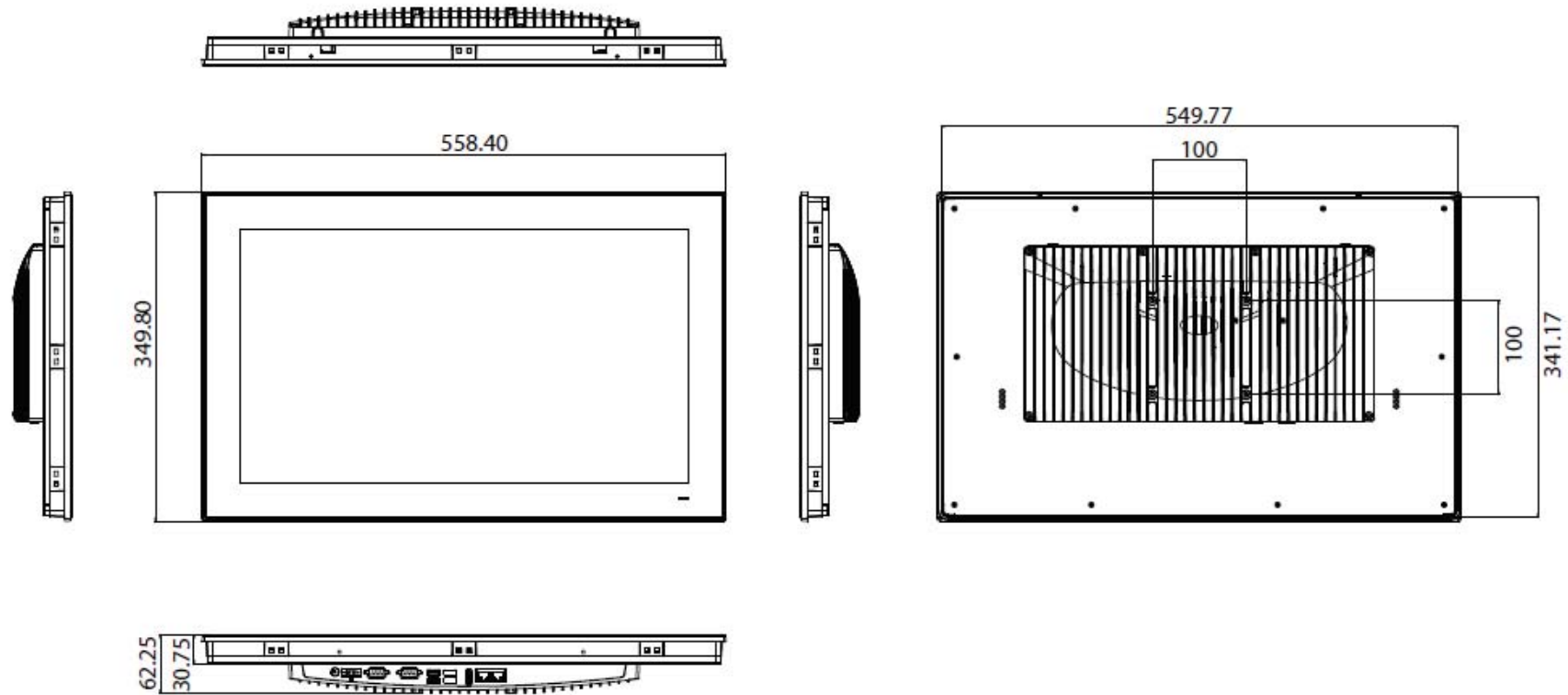

Cut-out dimension: 550.3 x 341.8 mm

Enabling an Intelligent Planet

ADVANTECH

Dimensions of PPC-3181SW

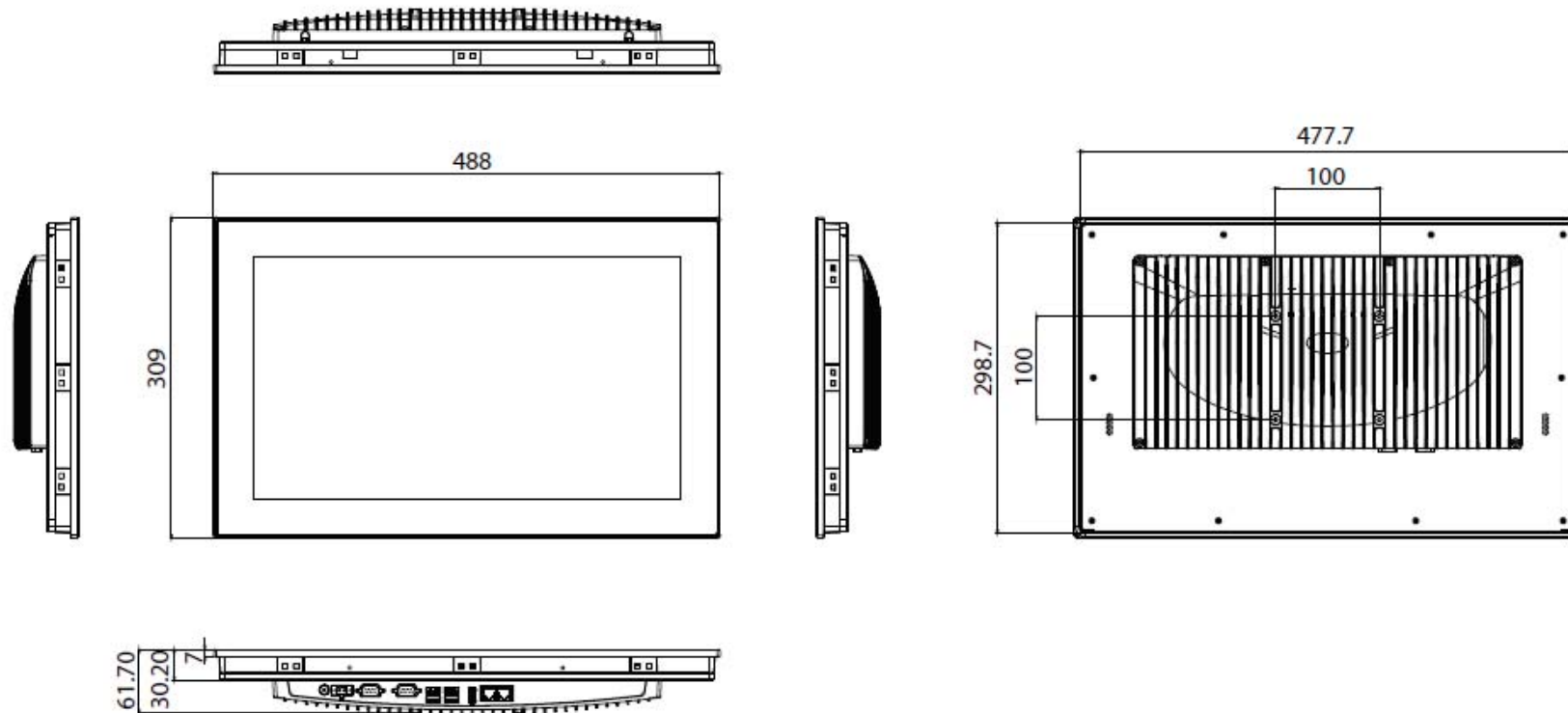

Cut-out dimension: 479.3 x 300.3 mm

Enabling an Intelligent Planet

ADVANTECH

Ideal for MES solutions with reliability, flexibility and easy integration

Fanless Design

Excellent passive cooling for dusty environment operation.
High stability and outstanding MTBF.



Wide Range Power Input

From **12V** to **24V** to fulfill different applications

Superior Thermal Design

Patented thermal design for
Core i computing solution.



Robust & Anti-Vibration

Solid aluminium enclosure;
Mechanical protection up to **2G** vibration
and **10G** shock



Easy integration

21.5" & **18.5"** True flat front panel with
IP65 protection
Panel mounting and VESA 100 support

EMC & Safety Certifications



High C/P Value

Simple with essential IO function

Enabling an Intelligent Planet

ADVANTECH

Ideal for MES solutions

with reliability, flexibility and easy integration



Powerful 6^o Gen. SkyLake CPU



P-Cap True Flat Monitor IP65



Aluminium Alloy Enclosure



Ideal for Shop Floor MES Application



21.5" & 18.5"

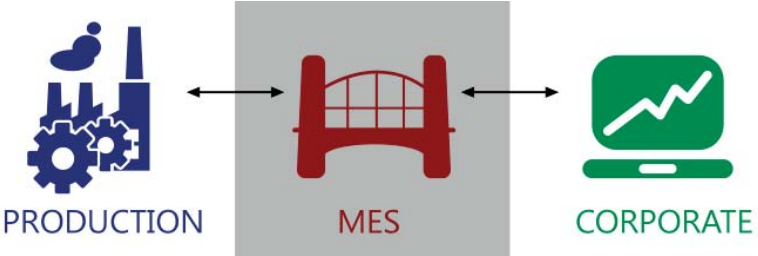

Enabling an Intelligent Planet



Benefit from Intel 6th Gen Core i

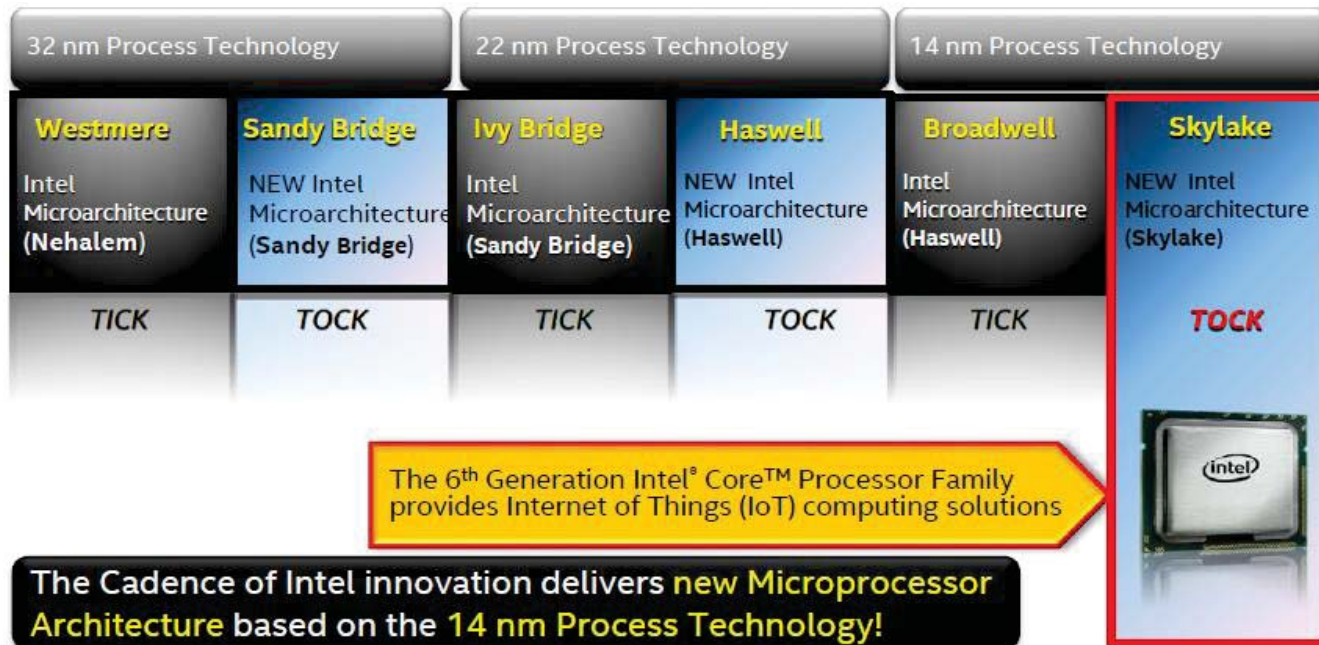

Advancement

- ✓ Better CPU performance at lower power
- ✓ Fast memory DDR4 of long-life designs
- ✓ Up to 50% better 3D graphic
- ✓ Flexible and high speed IO
- ✓ Added security

Large optimized Ratio Wide Screen with True flat

- Slim, Simple and Low profile
- Optimized Ratio Wide screen – **21.5" & 18.5" (16:9)**
- Entirely **True Flat** panel, easy to clean
- Compliant to **IP65** front panel design
- Light yet Robust aluminum / Magnesium die-cast front bezel

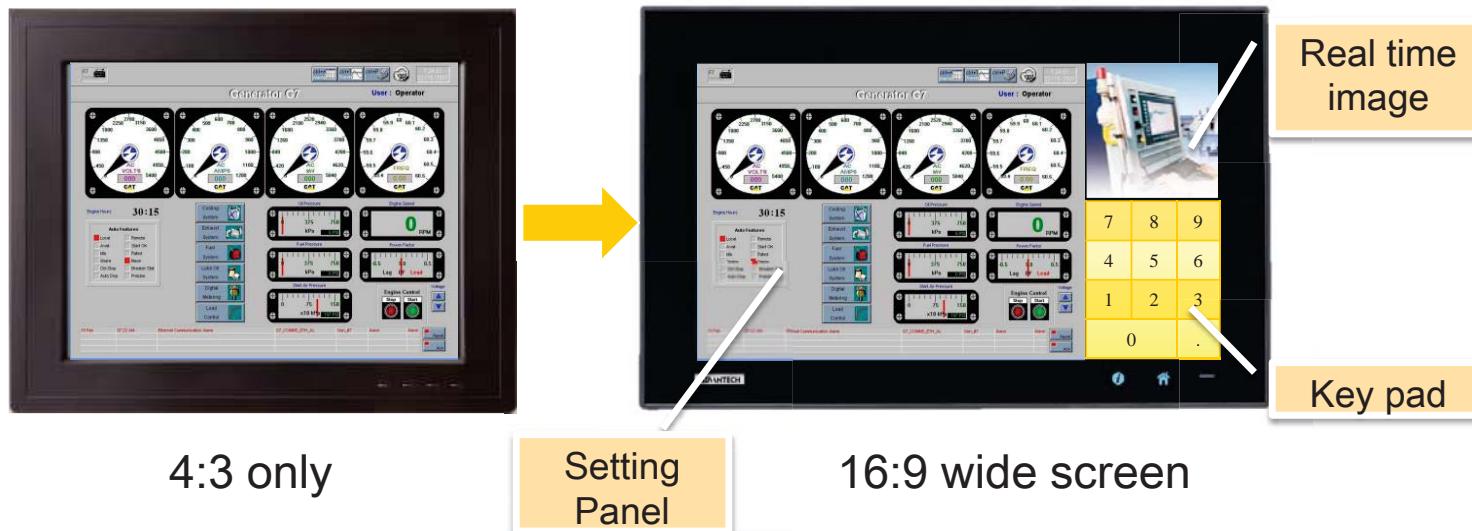

**Increase
40 % Space**

Multi-touch Benefit



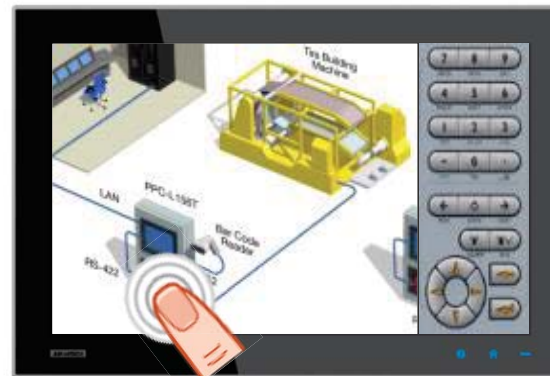
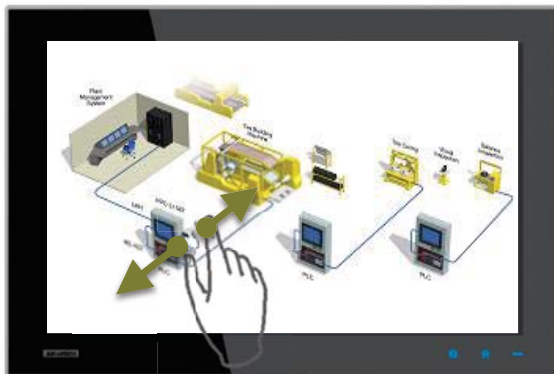
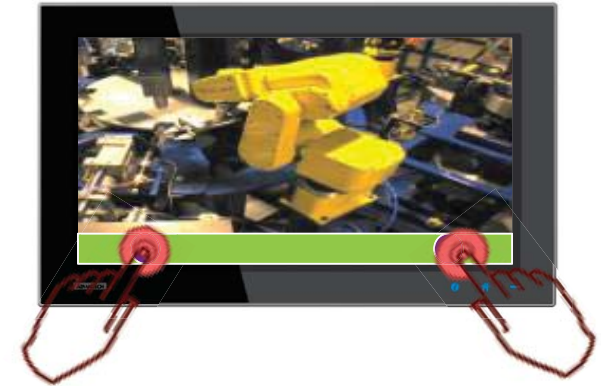



- Two-Hands Safety
 - Machine adjustment, Recipe adjustment
- Zoom In/Out
 - Positioning, detail information or statistics chart
- Swiping & Multi-Fingers
 - 3D model Rotation, Scrollable toolbars,
 - Drag & drop individual screen elements in the runtime
- Intuitive experience



Enabling an Intelligent Planet

ADVANTECH

Ordering Information

Item	Description	Image
PPC-3211SW-P65A	21.5" Fanelss Panel PC with Intel Core i5-6300U, Pcap multi touch	
PPC-3181SW-P65A	18.5" Fanelss Panel PC with Intel Core i5-6300U, Pcap multi touch	
96PSA-A90W19OT-1	Power Adapter, AC100 ~ 240V, 90W, 19V	
PPC-WLAN-B1E	WiFi module with wireless card and antenna	
PPC-ARM-A03	ARM kit	
PPC-174T-WL-MTE	Wall mounting kit	
PPC-Stand-A1E	Standing kit	